

vtech[®]

Parent's Guide

Starlight Vacation Camper™



91-003837-000 (US)

INTRODUCTION

Thank you for purchasing the **Starlight Vacation Camper™!**

Climb aboard for a light-filled journey! Drive to your spot, then open to reveal the cool camper interior. Go camping with friends and project a starry light show! Explore colors, seasons and weather with two adult characters, a baby and a Talking Point location that plays fun sounds, music and phrases.

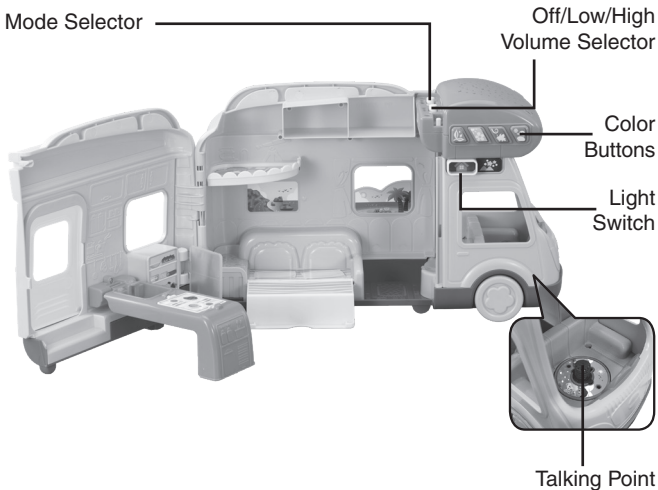

INCLUDED IN THIS PACKAGE

NOTE: This toy is not intended for teething.

- **Starlight Vacation Camper™**
- Parent's guide

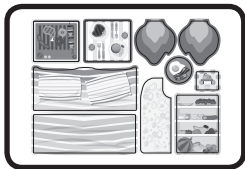

- Three characters
- One label sheet



- One campfire
- One pan
- One suitcase
- Two chairs

WARNING

All packing materials such as tape, plastic sheets, packaging locks, removable tags, cable ties and packaging screws are not part of this toy, and should be discarded for your child's safety.

NOTE

Please keep this parent's guide as it contains important information.

ATTENTION

Pour la sécurité de votre enfant, débarrassez-vous de tous les produits d'emballage tels que rubans adhésifs, feuilles de plastique, attaches, étiquettes et vis d'emballage. Ils ne font pas partie du jouet.

NOTE

Il est conseillé de conserver ce guide des parents car il comporte des informations importantes.

Unlock the Packaging Lock

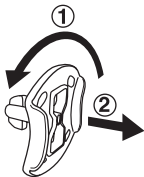

- ① Rotate the packaging lock 90 degrees counterclockwise.
- ② Pull out the packaging lock and discard.

Note: Please cut and discard the paper ties as shown in the pictures before playing with the unit. The paper ties are not part of the product and should be discarded for your child's safety.



GETTING STARTED

Battery Removal and Installation

1. Make sure the unit is turned **Off**.
2. Find the battery cover located on the bottom right of the unit and use a screwdriver to loosen the screw and open the battery cover.
3. Remove old batteries by pulling up on one end of each battery.
4. Install 2 new AA size (LR6/AM-3) batteries following the diagram inside the battery box.
5. Replace the battery cover and tighten the screw to secure.

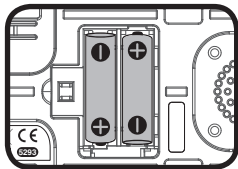
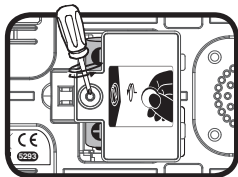

BATTERY NOTICE

- Use new alkaline batteries for maximum performance.
- Use only batteries of the same or equivalent type as recommended.
- Do not mix different types of batteries: alkaline, standard (carbon-zinc) or rechargeable, or new and used batteries.
- Do not use damaged batteries.
- Insert batteries with the correct polarity (+ and -).
- Do not short-circuit the battery terminals.
- Remove exhausted batteries from the toy.
- Remove batteries during long periods of non-use.
- Do not dispose of batteries in fire.
- Do not charge non-rechargeable batteries.

- Remove rechargeable batteries from the toy before charging (if removable).
- Rechargeable batteries are only to be charged under adult supervision.

MISE EN GARDE

Les piles fournies avec le produit permettent de tester le jouet en magasin mais ne sont pas des piles longue durée.

- Seules des piles du type recommandé doivent être utilisées.
- Ne pas mélanger différents types de piles ou d'accumulateurs, ne pas mélanger des piles ou des accumulateurs neufs avec des usagés.
- Ne pas utiliser des piles ou des accumulateurs endommagés.
- Mettre en place les piles ou les accumulateurs en respectant les polarités + et –.
- Ne pas mettre les bornes d'une pile ou d'un accumulateur en court-circuit (en reliant directement le + et le –).
- Enlever les piles ou les accumulateurs usagés du jouet.
- Retirer les piles ou les accumulateurs en cas de non-utilisation prolongée.
- Ne les jeter ni au feu ni dans la nature.
- Ne pas tenter de recharger des piles non rechargeables.
- Enlever les accumulateurs du jouet pour les recharger.
- Les accumulateurs ne doivent être chargés que sous la surveillance d'un adulte.

NOTE

This product is in Try-Me mode in the packaging. To activate Normal Play mode, please follow these steps.

1. Turn the unit On.
2. Place one of the adult characters on the Talking Point.
3. When you hear two short sounds, normal game play has been activated.

LABEL APPLICATION

Please securely stick the labels to the playset as indicated below:



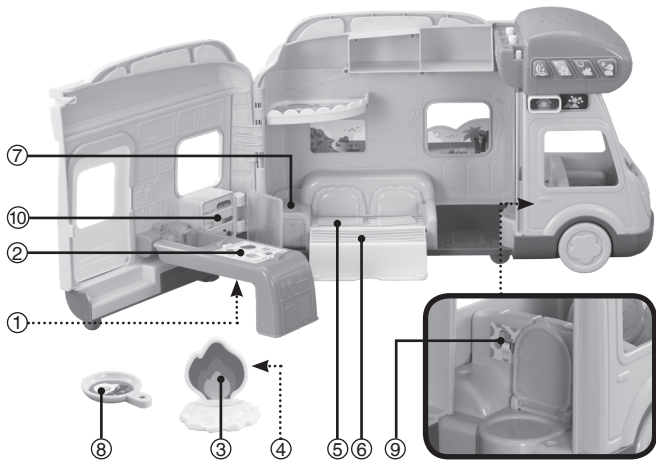



PRODUCT FEATURES

1. Off/Low/High Volume Selector

To turn the unit **On**, slide the **Off/ Low/High Volume Selector** to either the Low volume (||) or High volume (|||) position. To turn the camper **Off**, slide the switch to the **Off** (●) position.



2. Mode Selector

Slide the **Mode Selector** to the right to enter Learning mode . Slide the **Mode Selector** to the middle to enter Camping Fun mode . Slide the **Mode Selector** to the left to enter Nighttime mode .





3. Color Buttons

Press the four **Color Buttons** to learn about colors, the seasons and weather.



4. Light Switch

Slide the **Light Switch** to the left  to see beautiful lights shine inside the camper. Slide the **Light Switch** to the right  to see beautiful lights shine above the camper. Turn off the unit if you feel uncomfortable.



5. Push Along

Hear songs and phrases as you roll along.



6. Talking Point

Place the adult characters onto the **Talking Point** location to hear songs and phrases.



7. Transformation

The camper can be opened to show the interior living space, and closed again to go for a drive. Hear fun sounds when you open or close the camper.

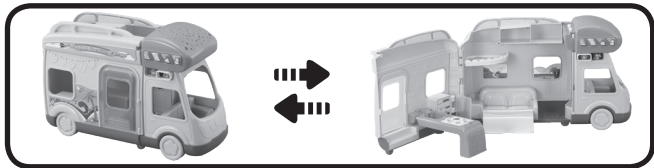

8. Automatic Shut-Off

To preserve battery life, the **Starlight Vacation Camper™** will automatically shut off after several minutes of no input. The unit can be turned on again by sliding the **Off/Low/High Volume Selector** to the Low volume position or High volume position, or by sliding the **Mode Selector** to Learning mode, Camping Fun mode or Nighttime mode position or by sliding the **Light Switch** to the left or right position.

NOTE

If the unit powers down or if the light fades out during play, please install a new set of batteries.

ACTIVITIES

Mode 1: Learning Mode

Slide the **Mode Selector** to the right position to enter this mode. Press the four **Color Buttons** to learn about colors, the seasons and weather. Place the adult characters onto the **Talking Point** location to hear fun sounds.

Mode 2: Camping Fun Mode

Slide the **Mode Selector** to the middle position to enter this mode. Press the four **Color Buttons** to hear what we can do while camping during the different seasons. Place the adult characters onto the **Talking Point** location to hear them talk and sing.

Mode 3: Nighttime Mode

Slide the **Mode Selector** to the left position to enter this mode. Press the four **Color Buttons** to hear melodies. Place the adult characters onto the **Talking Point** to hear them hum and talk.

SONG LYRICS

Song 1:

Hop on!
Family road trips are really fun!
Laughing and singing under the sun.

Song 2:

The world is full of things to see!
From high, high mountains, to low valleys,
Big, big trees and little bumblebees,
How lucky are we! Yeah!

Song 3:

In the night sky, the stars are bright!
We're together under the moonlight,
Telling jokes and stories at our campsite.

Song 4:

When we find our campsite, we set up camp!
We set up camp!
When it gets dark, we turn on our party lamp!
Our party lamp!

Song 5:

Camping is a great way to be outdoors.
When you're outside you can imagine
Flowers or dinosaurs!

CARE & MAINTENANCE

1. Keep the unit and its metal parts clean by wiping it with a slightly damp cloth.
2. Keep the unit out of direct sunlight and away from any direct heat sources.
3. Remove the batteries when the unit will not be in use for an extended period of time.
4. Do not drop the unit on hard surfaces and do not expose the unit to moisture or water.

EPILEPSY WARNING

Due to a pre-existing condition, a small percentage of users may experience epileptic seizures when viewing flashing lights or patterns.

Please consult your doctor if you have an epileptic condition or experience any unusual symptoms while playing.

TROUBLESHOOTING

If for some reason the toy stops working or malfunctions while a character is on the **Talking Point** location, please remove the character and place it back onto the **Talking Point**. If the toy still does not function, or if for some reason the toy stops working or malfunctions, please follow these steps:

1. Turn the unit **Off**.
2. Interrupt the power supply by removing the batteries.
3. Let the unit stand for a few minutes, then replace the batteries.
4. Turn the unit **On**. The unit should now be ready to use again.
5. If the unit still does not work, install a new set of batteries.

IMPORTANT NOTE

If the problem persists, please call our **Consumer Services Department** at **1-800-521-2010** in the U.S., **1-877-352-8697** in Canada, or visit our website **vtechkids.com** and fill out our **Contact Us** form located under the **Customer Support** link. Creating and developing VTech products is accompanied by a responsibility that we take very seriously. We make every effort to ensure the accuracy of the information, which forms the value of our products. However, errors sometimes can occur. It is important for you to know that we stand behind our products and encourage you to contact us with any problems and/or suggestions you might have. A service representative will be happy to help you.

NOTE

This equipment has been tested and found to comply with the limits for a Class B digital device, pursuant to Part 15 of the FCC Rules. These limits are designed to provide reasonable protection against harmful interference in a residential installation. This equipment generates, uses and can radiate radio frequency energy and, if not installed and used in accordance with the instructions, may cause harmful interference to radio communications. However, there is no guarantee that interference will not occur in a particular installation. If this equipment does cause harmful interference to radio or television reception, which can be determined by turning the equipment off and on, the user is encouraged to try to correct the interference by one or more of the following measures:

- Reorient or relocate the receiving antenna
- Increase the separation between the equipment and receiver
- Connect the equipment into an outlet on a circuit different from that to which the receiver is connected
- Consult the dealer or an experienced radio/TV technician for help

CAUTION

Changes or modifications not expressly approved by the party responsible for compliance could void the user's authority to operate the equipment.

Supplier's Declaration of Conformity
47 CFR § 2.1077 Compliance Information

Trade Name: VTech®
Model: 5293
Product Name: Starlight Vacation Camper™
Responsible Party: VTech Electronics North America, LLC
Address: 1156 W. Shure Drive, Suite 200
Arlington Heights, IL 60004
Website: vtechkids.com

THIS DEVICE COMPLIES WITH PART 15 OF THE FCC RULES. OPERATION IS SUBJECT TO THE FOLLOWING TWO CONDITIONS: (1) THIS DEVICE MAY NOT CAUSE HARMFUL INTERFERENCE, AND (2) THIS DEVICE MUST ACCEPT ANY INTERFERENCE RECEIVED, INCLUDING INTERFERENCE THAT MAY CAUSE UNDESIRED OPERATION.

CAN ICES-3 (B)/NMB-3(B)

**CLASS 1
LED PRODUCT**

**Visit our website for more
information about our products,
downloads, resources and more.**

vtechkids.com

Read our complete warranty policy online at
vtechkids.com/warranty

